

M6(2PCS)

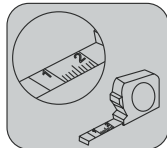

M6(2PCS)

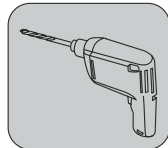
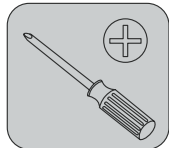
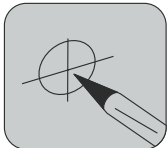

STEP1

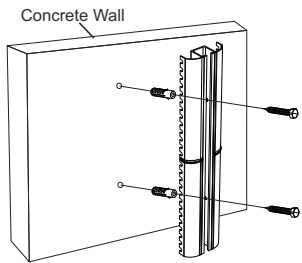

Concrete Wall

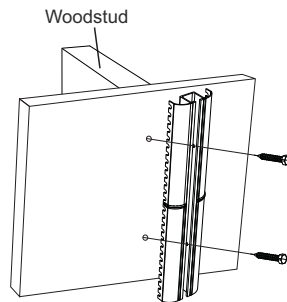

Woodstud

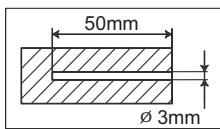
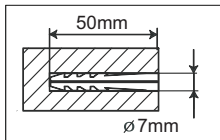

STEP2

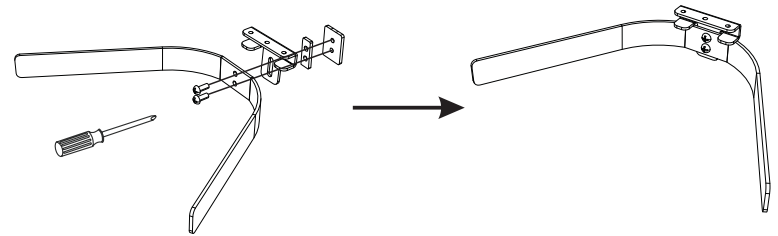

STEP3

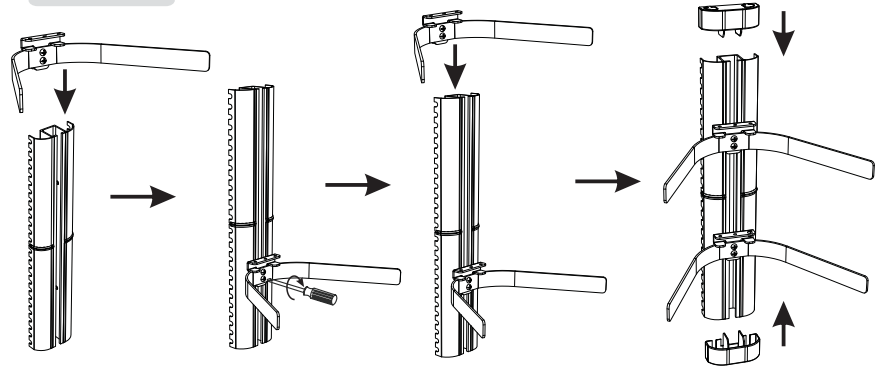

STEP4

