











- | | | | | |
|---|---|---|---|--|
| 
M4X12MM
A(4PCS) | 
M5X12MM
B(4PCS) | 
M6X12MM
C(4PCS) | 
M8X15MM
D(4PCS) | 
E(4PCS) |
| 
M6
F(3PCS) | 
M6
G(3PCS) | 
M6
H(7PCS) | 
I(4PCS) | 
J(4PCS) |



STEP1A Solid concrete mounting

Concrete Wall

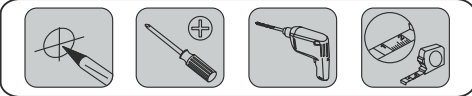
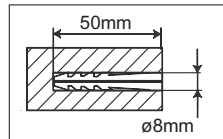
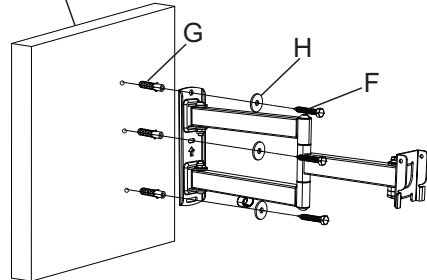

STEP1B Woodstud mounting

Woodstud

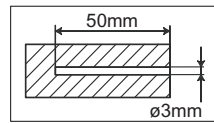
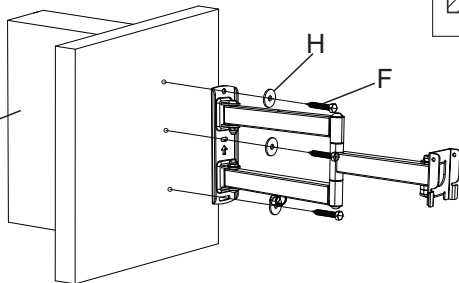

STEP2 Attaching brackets to screen

10"-36" TV

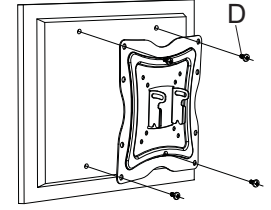
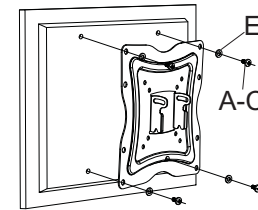

37"-50" TV

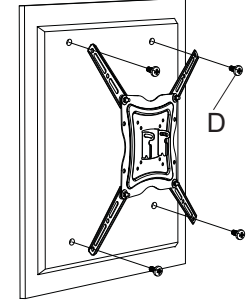
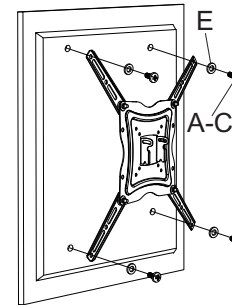
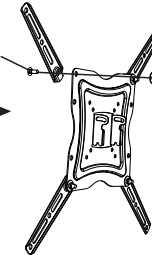

STEP3 Hang the TV onto the wall plate

Cable tie

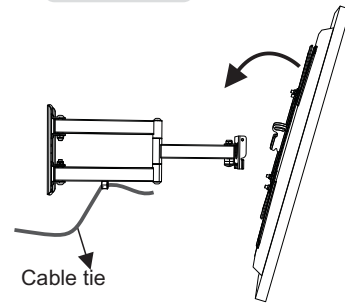

-5°/+15°

