









- |   |   |  |  |
|---|---|--|--|
| <br>M4X20MM<br>A(4PCS) | <br>M6X20MM<br>B(4PCS) | <br>M8X25MM<br>C(4PCS)      | <br>M6<br>D(4PCS) |
| <br>M6<br>E(4PCS)      | <br>M6<br>F1(8PCS)     | <br>bubblelevel<br>F2(1PCS) | <br>M6<br>G(4PCS) |



- 600x400
- Max 50kg
- 32"-60"
- 57mm
- 5°/+15°

### STEP1A Solid concrete mounting

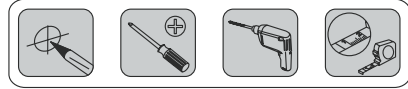
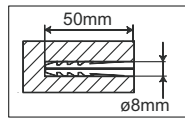
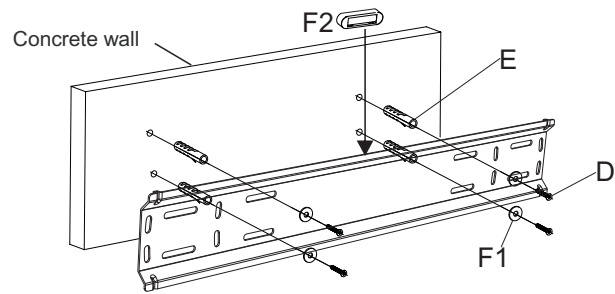

### STEP1B WoodStud mounting

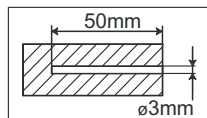
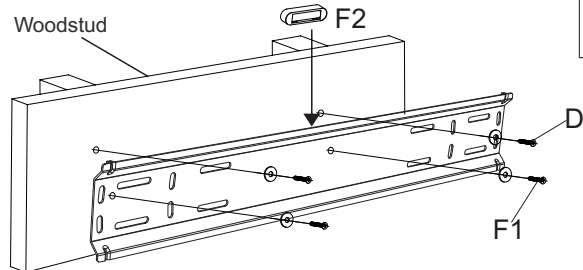

### STEP2A Attaching Brackets to screen

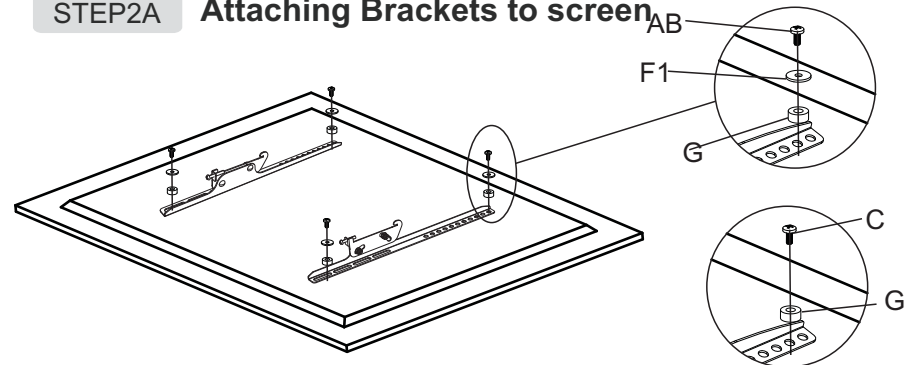

### STEP2B For TVs with a curved back or obstruction

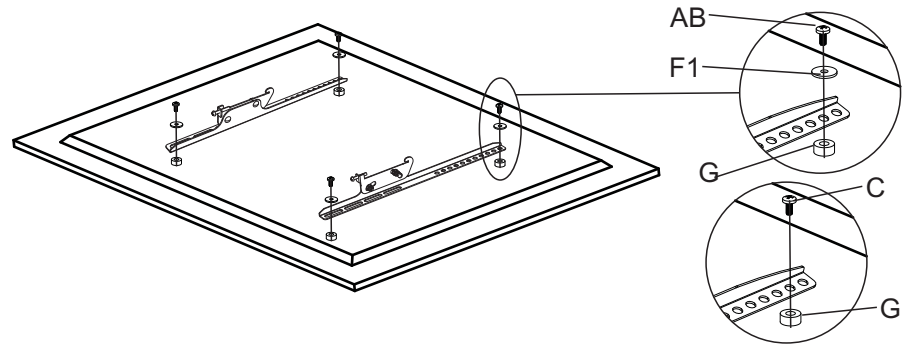

### STEP3 Hang the TV onto the wall plate

