









- | | | | |
|---|---|--|---|
| 
M4X20MM
A(4PCS) | 
M6X20MM
B(4PCS) | 
M8X25MM
C(4PCS) | 
M6
D(4PCS) |
| 
M6
E(4PCS) | 
M6
F1(8PCS) | 
bubblelevel
F2(1PCS) | 
G(4PCS) |



-  400x400
-  Max 45kg
-  32"-50"
-  57mm
-  -5°/+15°

STEP1A Solid concrete mounting

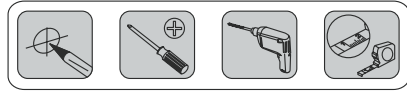
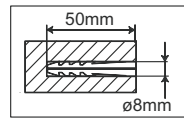
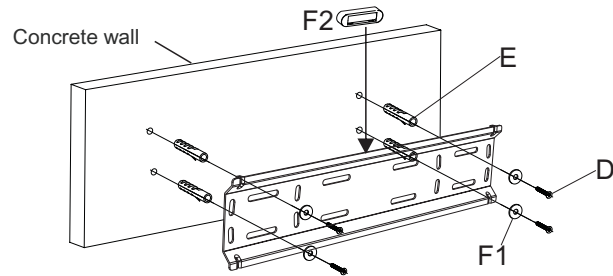

STEP1B WoodStud mounting

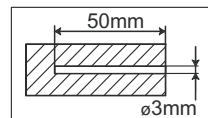
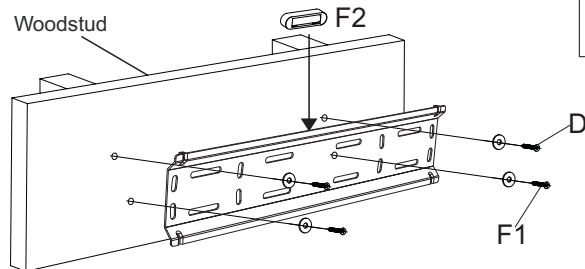

STEP2A Attaching Brackets to screen

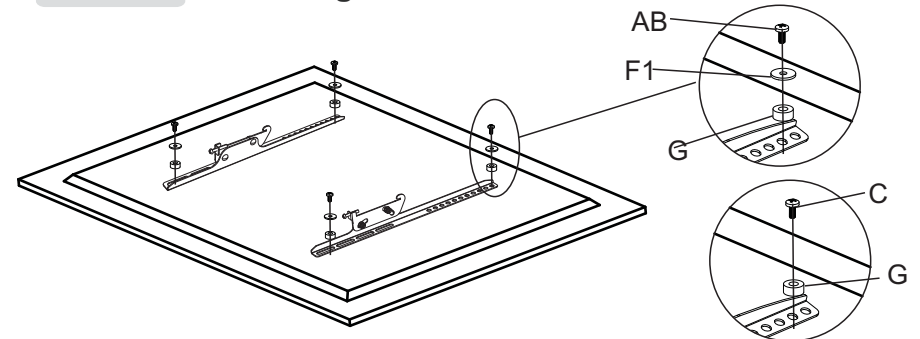

STEP2B For TVs with a curved back or obstruction

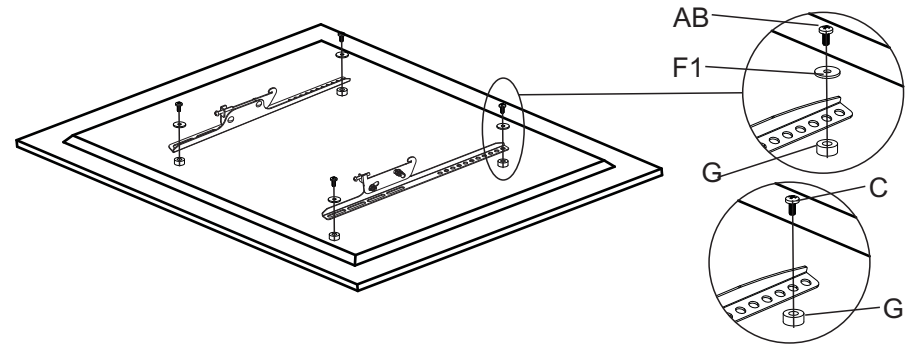

STEP3 Hang the TV onto the wall plate

